

# EDU 02

## Solar Energy Experiment Kit

*Nederlands  
Français  
Deutsch  
Español  
Italiano*



[www.velleman.eu](http://www.velleman.eu)

AGE  
12+



**velleman**<sup>®</sup>  
projects



**VELLEMAN NV**  
**Legen Heirweg 33**  
**9890 Gavere**  
**Belgium Europe**  
**[www.velleman.be](http://www.velleman.be)**  
**[www.velleman-kit.com](http://www.velleman-kit.com)**

## 10 exciting solar projects which you can actually use.

### Projects featured in this box:

<i>Solar-Powered LED</i> .....	<i>As long as the sun shines, the LED will light</i> <b>(pag.8)</b>
<i>Flashing Solar LED</i> .....	<i>Solar-powered attention grabber</i> <b>(pag.10)</b>
<i>Solar-Powered Cricket</i> .....	<i>As long as the sun shines, the cricket will chirp</i> <b>(pag.12)</b>
<i>Simple Solar Battery Charger</i> .....	<i>Free energy to keep your batteries in shape</i> <b>(pag.14)</b>
<i>Solar Battery Charger with 'Charge' Indicator</i> .....	<i>An LED turns on when the batteries are charging</i> <b>(pag.16)</b>
<i>Solar Musical Instrument</i> .....	<i>More light = higher note</i> <b>(pag.18)</b>
<i>IR Remote Control Tester</i> .....	<i>'Listen' to your IR remote</i> <b>(pag.20)</b>
<i>Solar Garden Light</i> .....	<i>LED turns on at dusk and turns off at dawn, fully automatic</i> <b>(pag.22)</b>
<i>Solar Motion Detector / Beam Break Detector</i> .....	<i>Announce wanted or unwanted guests</i> <b>(pag.24)</b>
<i>Solar-Powered 'Alarm Armed' LED</i> .....	<i>Charges during the day, scares burglars at night</i> <b>(pag.26)</b>

Attention: All projects require direct sunlight or a strong incandescent lightbulb (min 60W). Fluorescent, energy saving, led and certain halogen lightsources are not suited or will not give satisfactory results.



## Parts supplied with this kit:

### 4V / 30mA solar cell

This device will convert sunlight into electricity, which we will use in all projects. More light means more electricity. Point the black surface towards the sun.

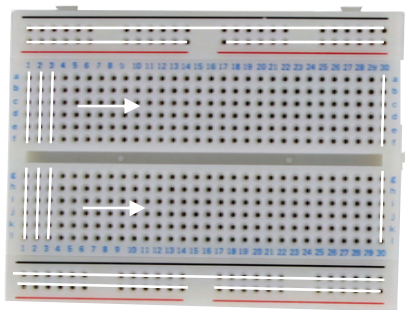

### Breadboard

Will hold all your experiments. The white lines show how the holes are electrically connected with each other (Velleman part# SDAD102)

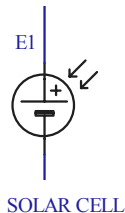

## Ultrabright yellow & red LED

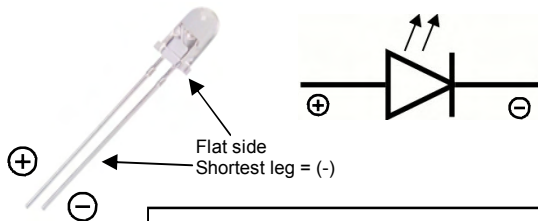

The yellow & red LED provide a lot of light and require a very low current to operate. Watch the polarity ! (Velleman part# L-5YAC & L-7104LID)

## Wire jumper

Just a piece of bare wire to connect two points in a circuit.

## Resistors

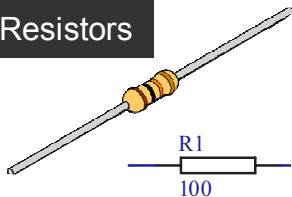

Various resistor values are supplied. They serve as current limiters or as voltage dividers. Resistors do not have a polarity. Resistor values are indicated by means of coloured rings. The unit of resistance is called 'Ohm'.



## Diode

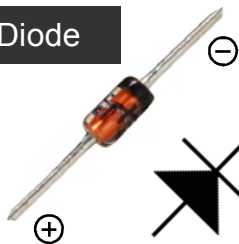

Diodes allow the current to flow in only one direction, from (+) to (-). Current flow in the opposite direction is blocked.

(Velleman part# BAT85)

A special case: Zener diodes  
Zener diodes allow the current to flow from (+) to (-), as regular diodes do. If you invert the polarity, they drop a certain voltage, which can be found on the body of the zener diode, e.g. 2V4= 2.4V

(Velleman part# ZA2V4)

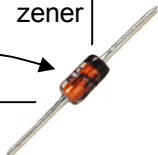

## Battery holder

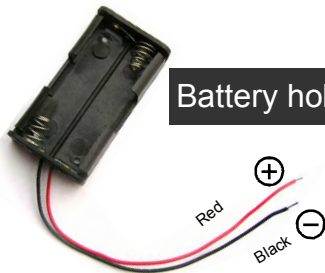

Holder for two AAA rechargeable batteries. Mind the polarity

(Velleman part# BH421A)

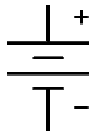

## Transistors

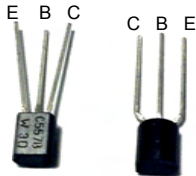

A transistor is an amplification device. By means of a small current, a much larger current is controlled. Transistors come in two flavours, NPN and PNP-types, depending on the polarity. With this kit, you receive a BC557 (PNP) transistor. A transistor has 3 pins: Base, Emitter and Collector. (Velleman part# BC557B)

## Piezo speaker

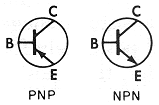

A piezo speaker converts an electric signal into sound. Polarity is not important (Velleman part# TV1)

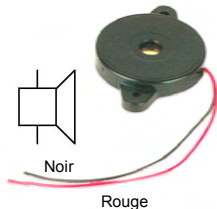

## Microcontroller ( $\mu$ C)

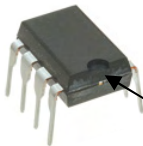

A programmable device which can perform various tasks. We have pre-programmed it so that it will play musical notes or it will generate the sound of a cricket. This device is has a polarity. Watch the position of the notch. (Velleman part# VKEDU02)



## Project 1: Solar Powered Led

As long as the sun shines, the led will light...

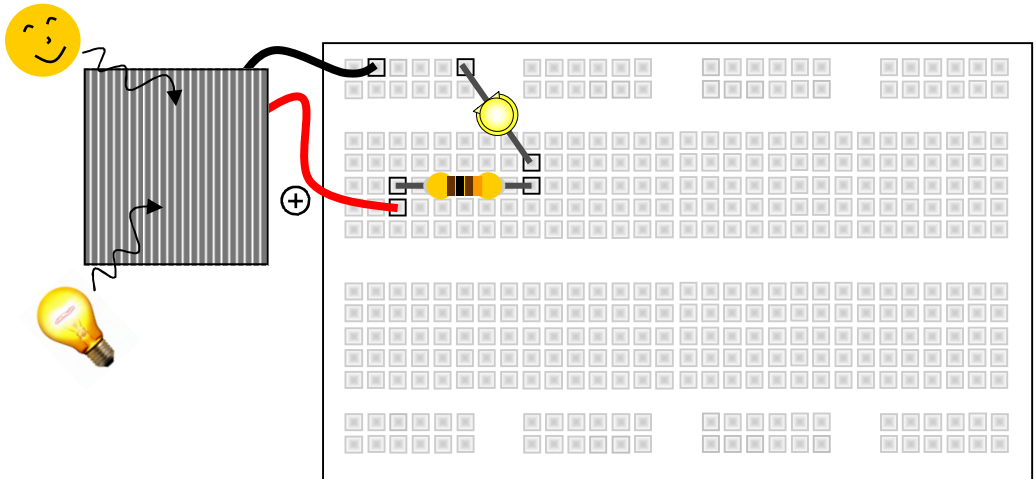



Required parts: Solar cell, 100 ohm resistor (brown black brown gold), yellow led

**How it works:** A closed circuit is required to make the current flow. Current flows from the (+) of the solar cell through resistor to the (+) of the led and via the (-) of the led back to the solar cell. On a sunny day, the solar cell will generate 3..4 volts. The led only requires 2 volts to operate. Resistor R1 converts the excess voltage into (a little) heat, hereby protecting the led from damage.

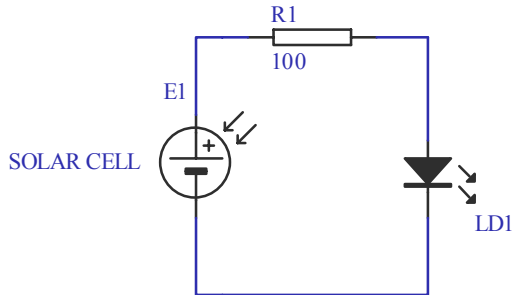

**Time to experiment:**

What happens when you swap (+) and (-) of the led?  
 What happens when you replace the 100 ohm resistor with a 47000 ohm resistor (yellow purple orange gold) ?



## Project 2: Solar Flashing Led

Solar powered attention grabber

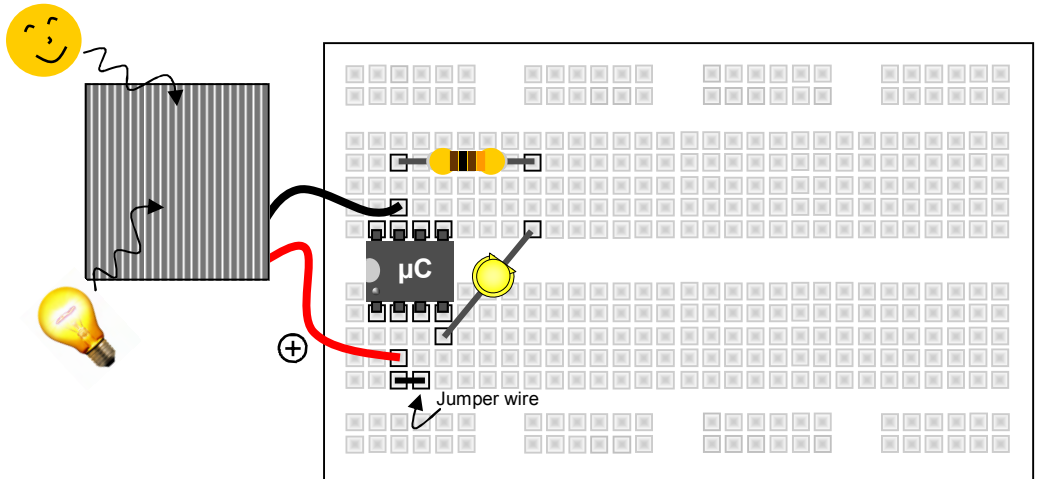

Required parts: Solar cell, 100 ohm resistor (brown black brown gold), yellow led, microcontroller ( $\mu\text{C}$ ), wire jumper.

**How it works:** The controller requires 2-5V to operate. This voltage is supplied by the solar panel. The microcontroller is pre-programmed with software that turns the output on and off in a loop. The signal is output via pin 4. When the output is on, current flows via the led and the resistor, hereby causing the led to light.

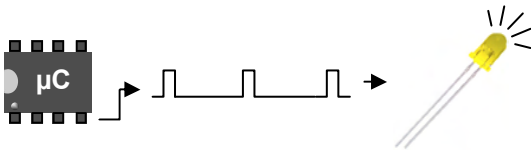
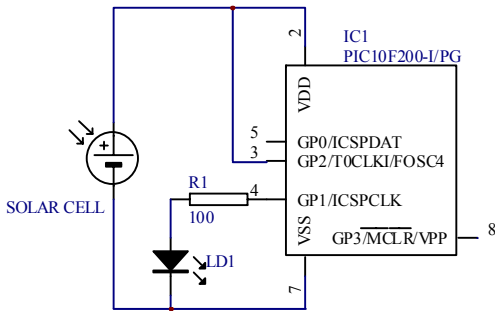



## Project 3: Solar Powered Cricket

As long as the sun shines, the cricket will chirp...

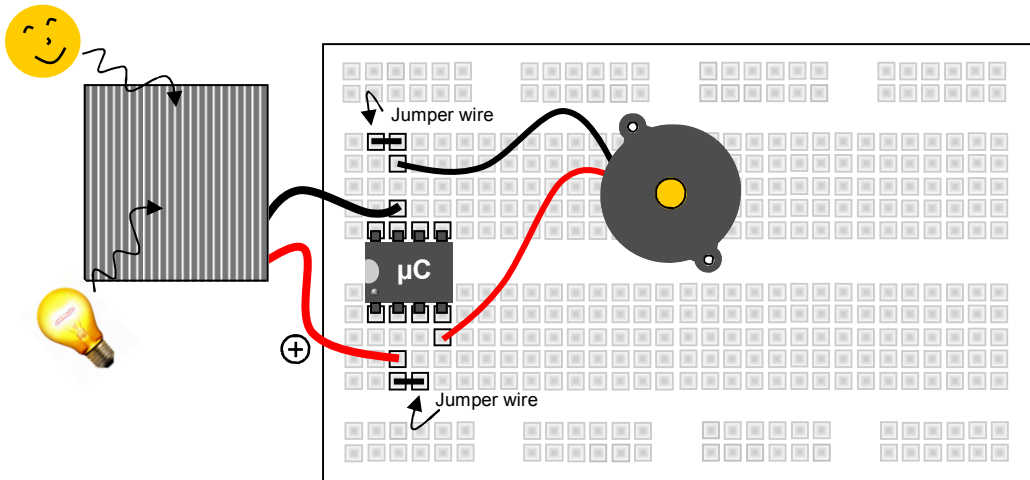

Required parts: Solar cell, microcontroller ( $\mu\text{C}$ ), piezo sounder, wire jumpers

**How it works:** The controller requires 2-5V to operate. This voltage is supplied by the solar panel. The microcontroller is pre-programmed with software that generates a realistic cricket chirp. The chirp signal is output via pin 4. The electrical signal is converted to sound via the piezo speaker.

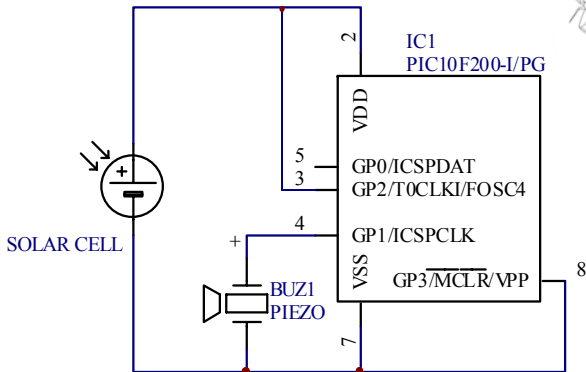
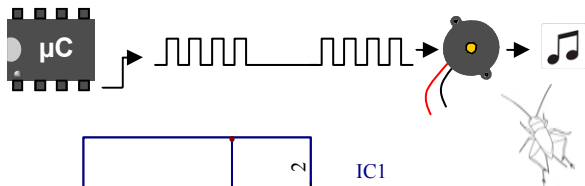

**Hint: Use this circuit as a wake-up-at-dawn alarm. It will wake you at sunrise...**



## Project 4: Simple Solar Battery Charger

Free energy to keep your batteries in shape...

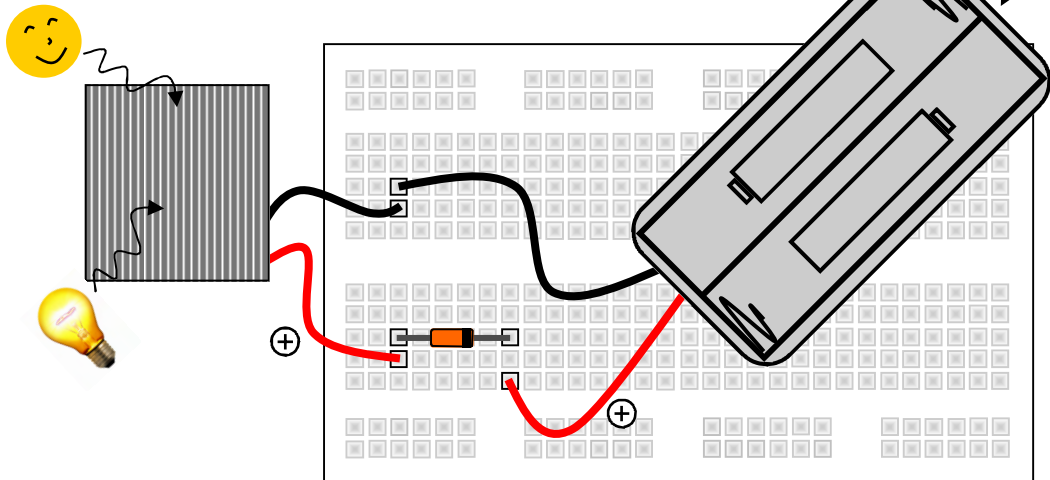

\*Not included

Required parts: Solar cell, BAT85 diode, battery holder for two AAA batteries, two AAA 1.2V rechargeable batteries.

**How it works:** As long as the solar cell is exposed to light, a current will flow from the solar cell via the diode through the batteries and back to the solar cell. The charge current depends on the amount of light that reaches the solar cell. Max. current with the supplied cell is 30mA.

A diode prevents discharge of the batteries through the solar cell (e.g. at nighttime), as it only allows the current to pass in one direction.

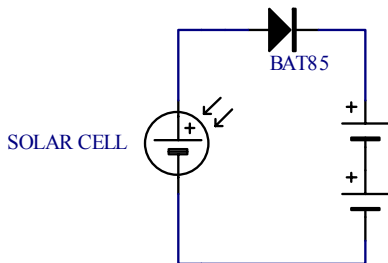

### How long does it take to fully charge the batteries?

Check the capacity of your batteries. You can find this info printed on the battery. Usually, it is expressed in mAh, e.g. 300mAh. Multiply by 1.2 = 360mAh.

Divide by 30mA = 12 hours

Twelve hours of bright sunlight are required to fully charge the batteries (rule of thumb).



## Project 5: Solar Battery Charger With 'charge'-Indicator

A led turns on when the batteries are charging...

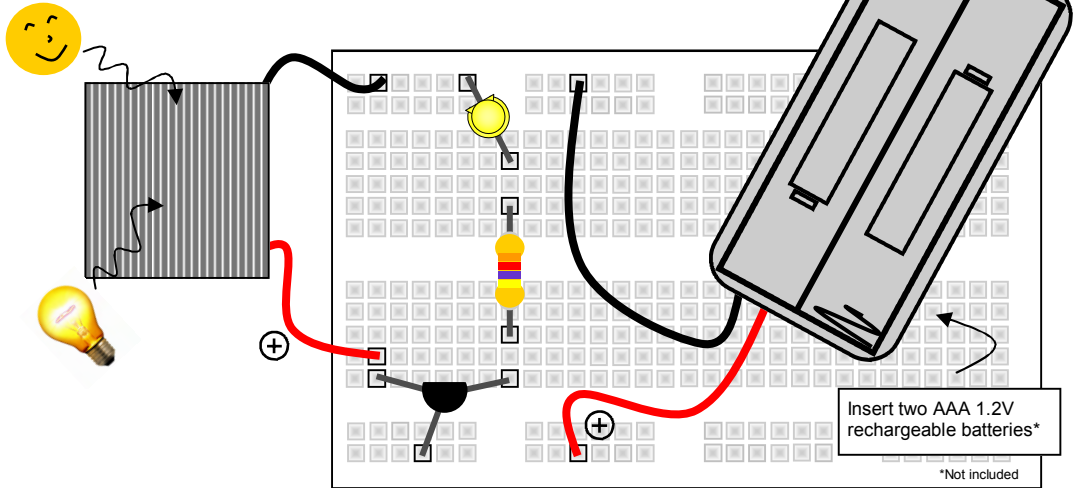



Required parts: Solar cell, BC557 transistor, 4K7 resistor (yellow, purple, red, gold), yellow led, battery holder for two AAA batteries, two AAA 1.2V rechargeable batteries.

**How it works:** When the sun shines, a current flows from the (+) of the solar cell via the Emitter/Base of the transistor through the batteries and back to the solar cell. This is the Base current, indicated with the dotted line. In our example, the Base current will also charge our batteries. The fact that there is a current flowing between Emitter and Base causes the transistor to turn on and fully conduct, as if it were a switch. Hence, a current can flow from the solar cell via the transistor Emitter/Collector and resistor to the led and back to the solar cell. This current causes the led to light (solid line).

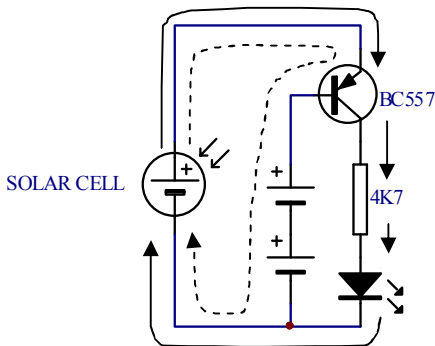

**For advanced users:**

The led turns off when the batteries are removed. Why ?  
In the simple battery charge circuit, there was a diode to prevent discharging of the batteries in low light condition. In this circuit, it has been omitted. Why ?



## Project 6: Solar Musical Instrument

More light = higher note

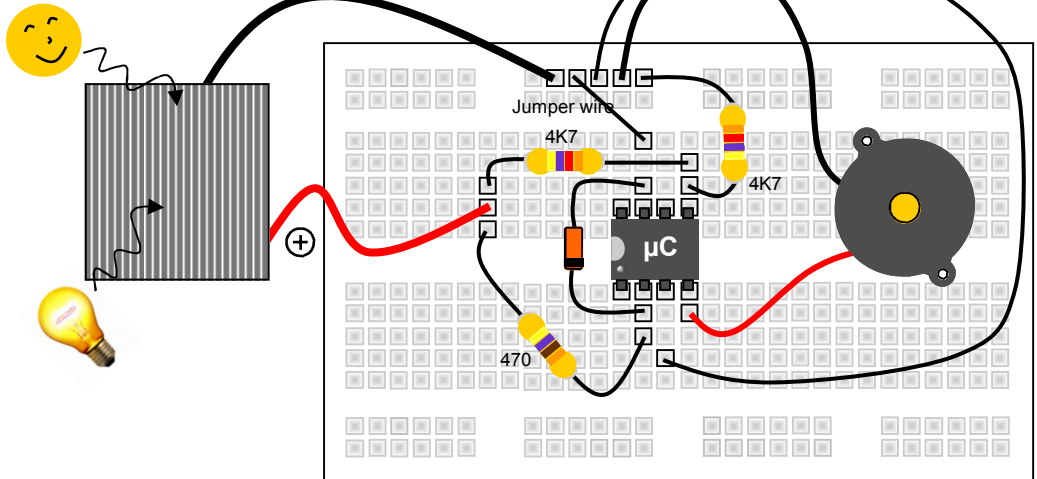

Required parts: Solar cell, microcontroller ( $\mu\text{C}$ ), 2x 4K7 resistor (yellow, purple, red, gold), 470 ohm resistor (yellow, purple, brown, gold), 2V4 zener diode, piezo sounder, wire jumpers, wire.

**How it works:** The solar cell provides the supply voltage for the microcontroller. Once it receives 2VDC it starts running its internal program. The zener diode and the 470 ohm resistor make sure the supply voltage of the controller never goes beyond 2.4V, even in bright sunlight. A too high voltage can damage the device. The voltage generated by the solar cell is also divided by two by means of two equal resistors (4K7) and fed to the analog input of the PIC. Even in bright sunlight, the input receives no more than  $4.5/2 = 2.25\text{VDC}$ .

The internal software 'measures' the voltage at the input and translates it to a variable audio frequency (note). The piezo sounder converts the signal into sound. When the amount of light received by the solar cell changes, the voltage at the input of the controller will also change. The software will notice this and change the tone. With a bit of practice, you could play a tune by waving your hand or a flashlight over the solar cell.

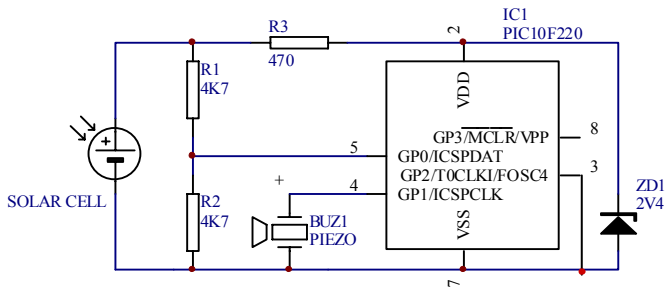



## Project 7: IR Remote Control Tester

'Listen' to your IR remote

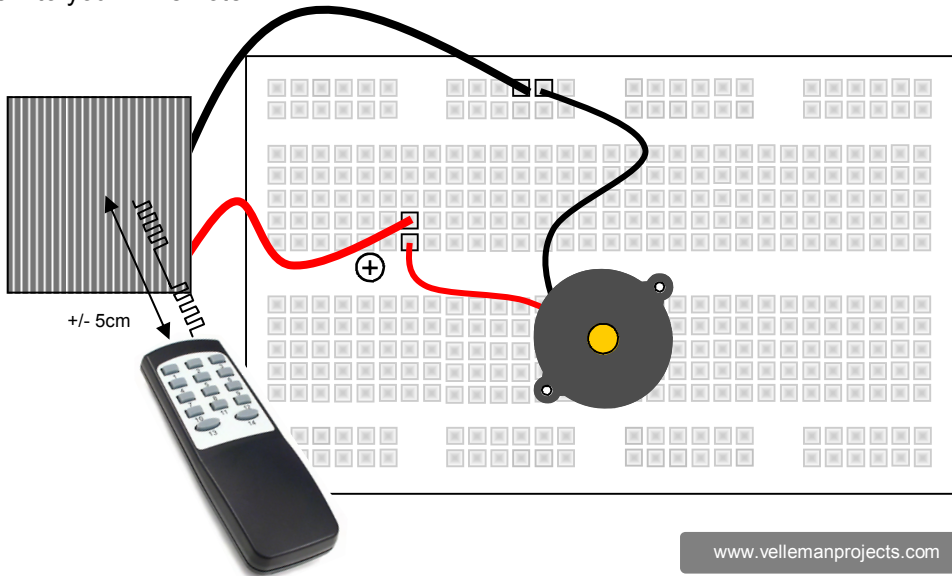

Required parts: Solar cell, piezo sounder, IR remote control (option).

**How it works:** Solar cells are sensitive to infrared light. When hit by infrared light, they generate a voltage, like they do with sunlight. IR remote controls generate a beam of infrared light when they are operated. This beam of light is turned on and off very fast by the internal electronics of the remote control. The pattern generated by the on-off transitions is different for each button of the remote. This allows the receiver to recognise each individual button. In this circuit, the on-off transitions are translated into sound by the piezo sounder.

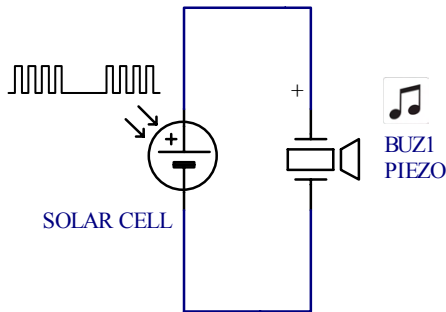

**More fun:**

Try 'listening' to different light sources such as led lighting, fluorescent lighting, etc...



## Project 8: Solar Garden Light

Led turns on at dusk and turns off at dawn, fully automatic

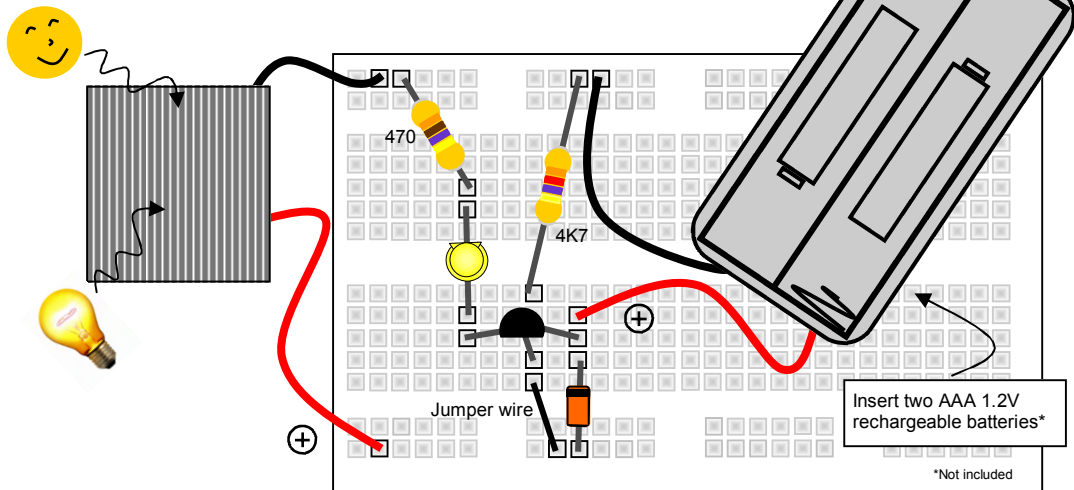

Required parts: Solar cell, BC557 transistor, 4K7 resistor (yellow, purple, red, gold), 470 ohm resistor (yellow, purple, brown, gold), BAT85 diode, yellow led, battery holder for two AAA batteries, two AAA 1.2V rechargeable batteries, jumper wire.

**How it works:** When the sun shines, the voltage generated by the solar cell will be higher than the voltage of the batteries, so a current will flow from the solar cell to the batteries. This current will charge the batteries. The BAT85 diode prevents discharging of the batteries through the solar cell in low light conditions. The base of the transistor is tied to ground (-) by means of the 4K7 resistor. This causes the transistor to turn on and allows a current to flow from the batteries through the transistor, the led and via 470 ohm resistor back to the batteries. The led will turn on. However, note that the base of the transistor is also tied to the (+) of the solar cell, so as long as the sun shines, the base of the transistor is kept high enough to prevent turn-on of the transistor, so the led remains off at daytime.

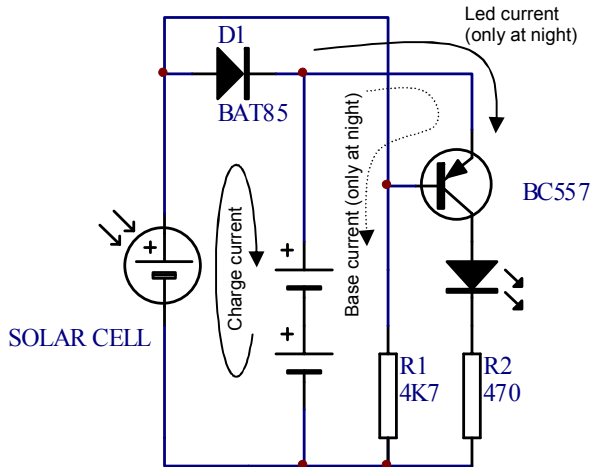



## Project 9: Solar Motion Detector / Beam Break Detector

Announce wanted or unwanted guests

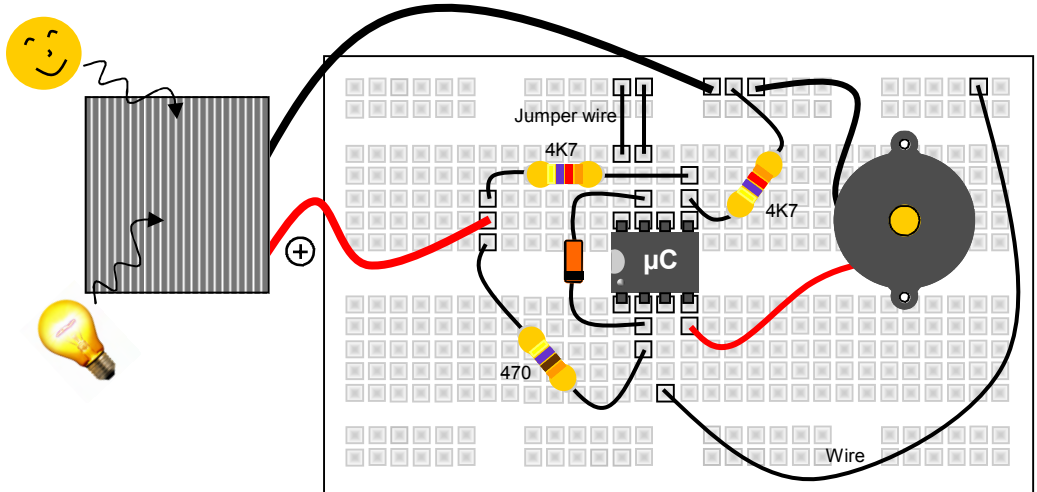



Required parts: Solar cell, microcontroller ( $\mu\text{C}$ ), 2x 4K7 resistor (yellow, purple, red, gold), 470 ohm resistor, (yellow, purple, brown, gold), 2V4 zener diode, piezo sounder, wire.

**How it works:** The solar cell provides the supply voltage for the microcontroller. Once the controller receives 2VDC it starts running its internal program. The zener diode and the 470 ohm resistor make sure the supply voltage of the controller never goes beyond 2.4V, even in bright sunlight. A too high voltage can damage the device. The voltage generated by the solar cell is also divided by two by means of two equal resistors (4K7) and fed to the analog input of the controller.

Even in bright sunlight, the input receives no more than  $4.5/2 = 2.25\text{VDC}$ .

The internal software 'measures' the voltage at the input and compares it to the previous level. When it detects a sudden change (i.e. When the beam is interrupted or someone casts a shadow on the solar cell), it generates a sound through the piezo.

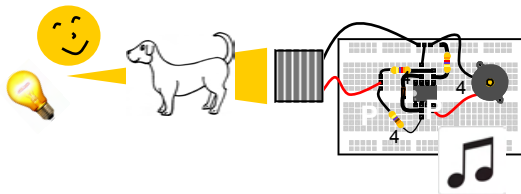
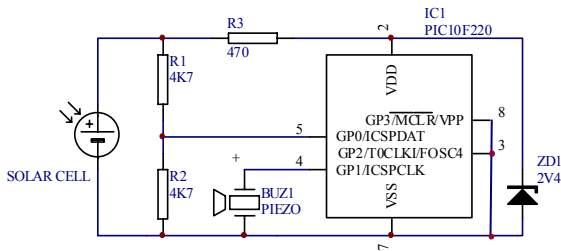



## Project 10: Solar Powered 'Alarm armed'-led

Charges during the day, scares burglars at night

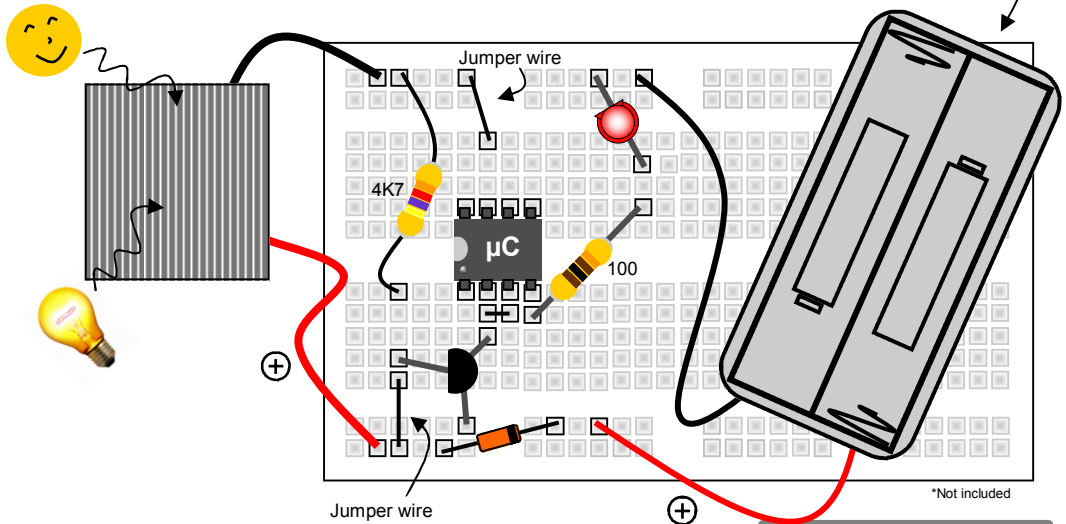

Required parts: Solar cell, microcontroller ( $\mu\text{C}$ ), 4K7 resistor (yellow, purple, red, gold), 100 ohm resistor, (brown, black, brown, gold), BAT85 diode, BC557 transistor, battery holder for two AAA batteries, two AAA 1.2V rechargeable batteries, wire jumpers, red led.

**How it works:** When the sun shines, the voltage generated by the solar cell will be higher than the voltage of the batteries, so a current will flow from the solar cell to the batteries. This current will charge the batteries. The BAT85 diode prevents discharging of the batteries through the solar cell in low light conditions. The base of the transistor is tied to ground (-) by means of the 4K7 resistor. This causes the transistor to turn on and supply power to the  $\mu\text{controller}$ . The controller will behave identical to project 2, so the led will flash. However, note that the base of the transistor is also tied to the (+) of the solar cell, so as long as the sun shines, the base of the transistor is kept high enough to prevent turn-on of the transistor, so the led remains off at daytime.

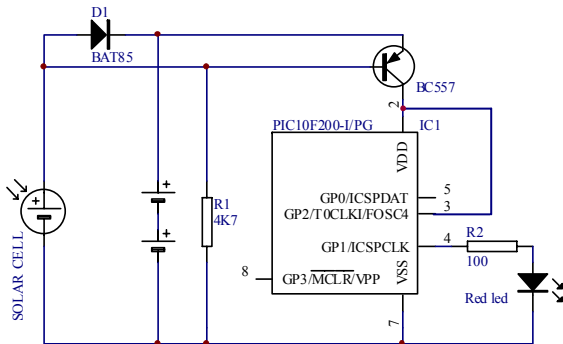

**VELBUS**  
Velleman Home Automation System

**All appliances get intelligent, how about your home?  
see our website : [www.velbus.be](http://www.velbus.be)**

Modifications and typographical errors reserved  
© Velleman nv.  
HEDU02 - 2010 - ED1

**VELLEMAN NV**  
**Legen Heirweg 33, 9890 Gavere**  
**Belgium - Europe**

